

2 1/4" CASING

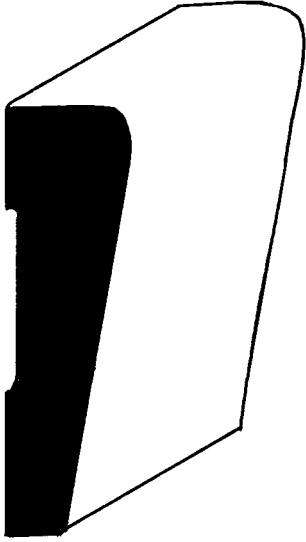

WM-327
Finger-Joint and Clear
11/16" X 2-1/4"

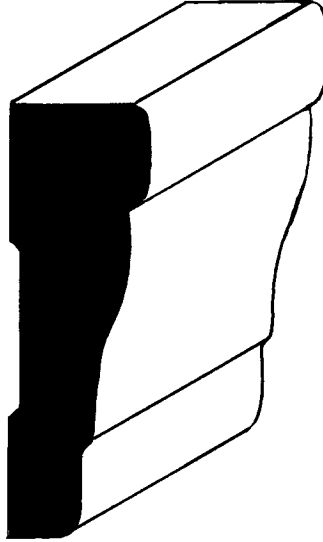

WM-356
Finger-Joint and Clear
11/16" X 2-1/4"

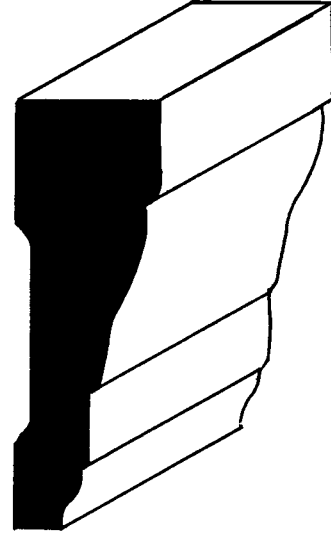

WM-366
Casing
Finger-Joint
11/16" X 2-1/4"

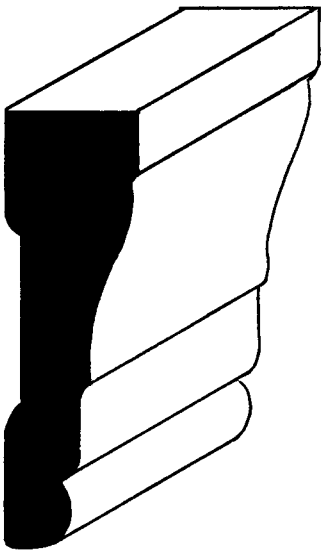

WM-376
Finger-Joint
11/16" X 2-1/4"

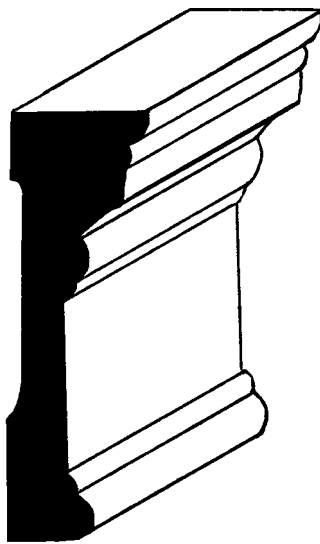

WM-1003M MINI-HOWE
Finger-Joint
11/16" X 2-1/4"

BACKBANDS

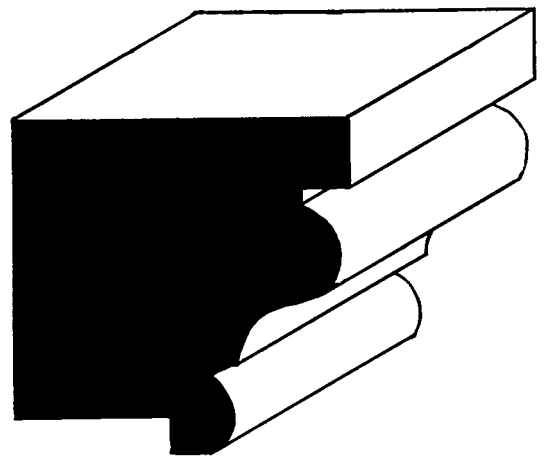

MB-51A
Poplar
1-3/4" X 1-1/4"
13/16" Datto

3 1/4" and 3 1/2" CASING

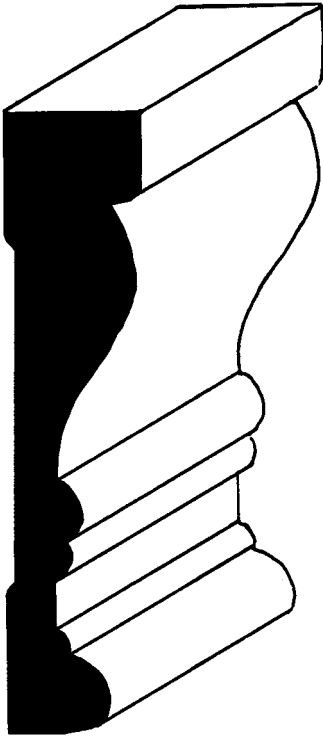

MB-10

Casing

Poplar and Maple, 13/16" X 3-1/4"

Finger-Joint – 11/16" X 3-1/4"

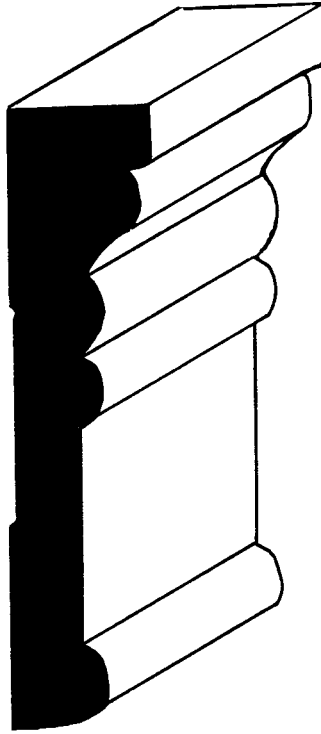

MB-11

Finger Joint, 13/16" X 3-1/4"

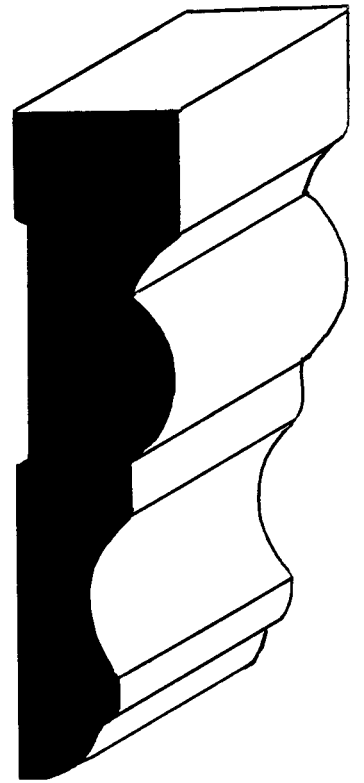

MB-12

Poplar, 13/16" X 3-1/2"

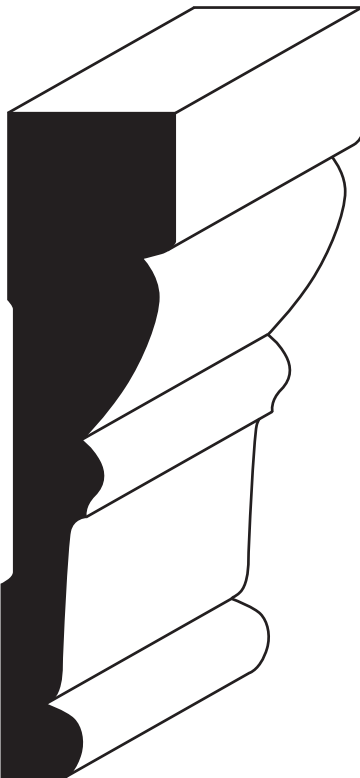

MB-14BNC

Poplar, 1-1/16" X 3-1/2"

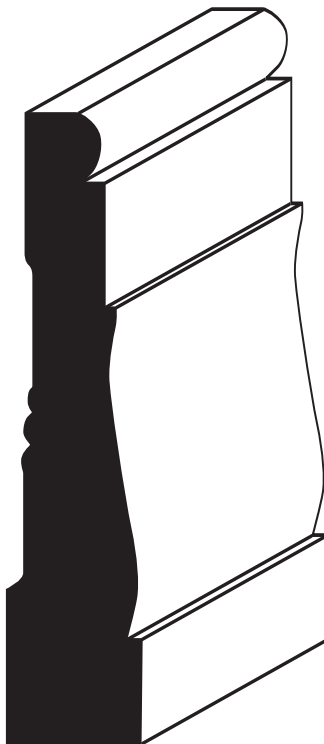

WM-445

Finger-Joint, Clear, 11/16" X 3-1/4"

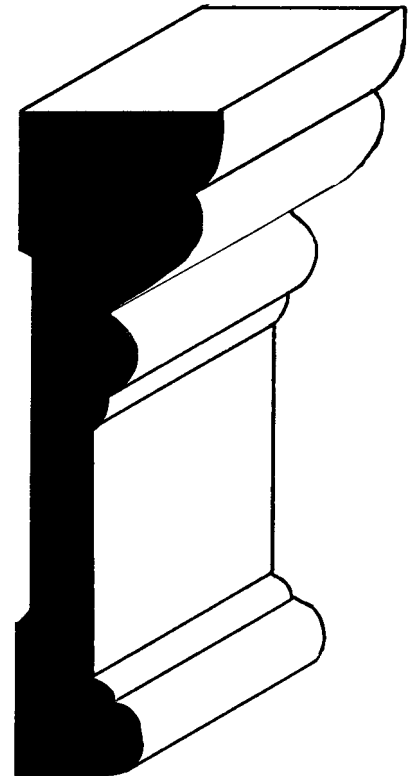

WM-523DH

Finger-Joint, Clear
1-1/16" X 3-1/2"

3 1/4" BASEBOARDS

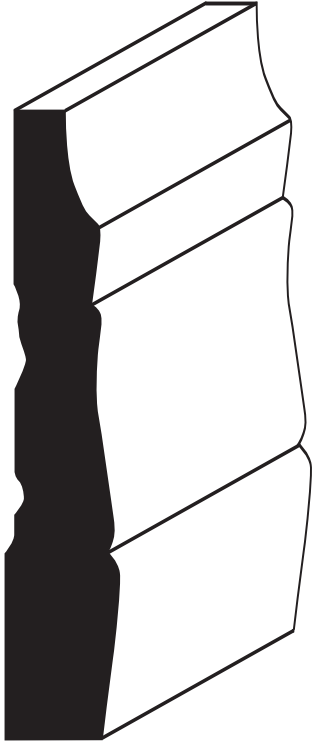

WM-366

Finger-Joint

9/16" X 3-1/4"

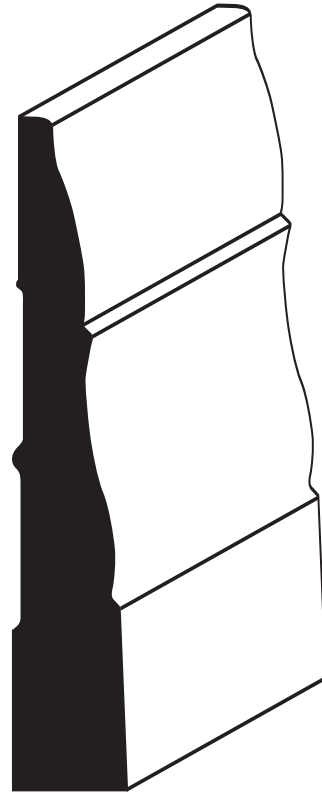

WM-444

Finger-Joint and Clear

9/16" X 3-1/4"

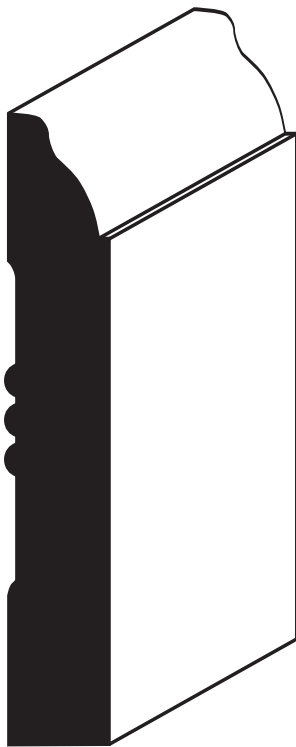

WM-623

Finger-Joint and Clear

9/16" X 3-1/4"



WM-713

Finger-Joint and Clear

9/16" X 3-1/4"

LARGE BASEBOARDS

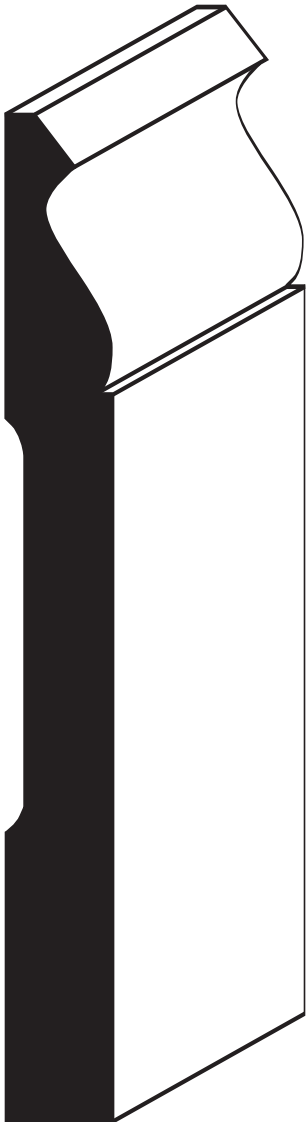

MB-514
Finger-Joint, Maple & MDF
5/8" X 5-1/4"



WM-618
Finger-Joint & Clear
9/16" X 5-1/4"

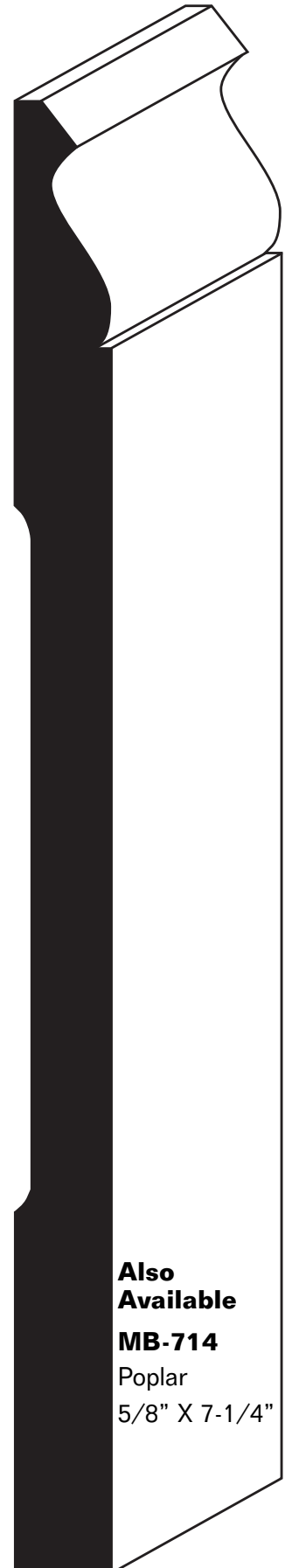

Also Available
MB-714
Poplar
5/8" X 7-1/4"

MB-834
Poplar
5/8" X 8-3/4"

MB-725
Finger-Joint
9/16" X 7-1/4"

REEDED, FLUTED & ROSETTES

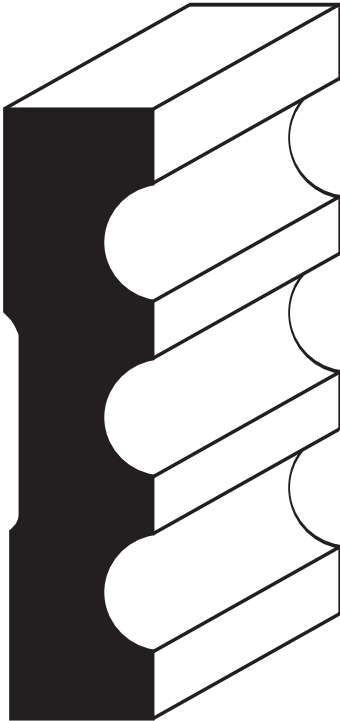

MB-8
Poplar
3/4" X 3-1/4"

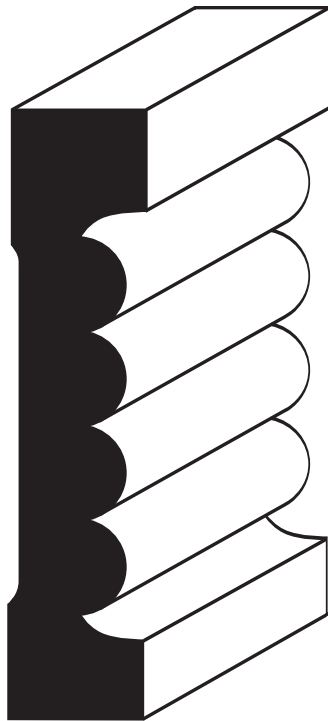

MB-9
Reeded Casing
Poplar
3/4" X 3-1/4"

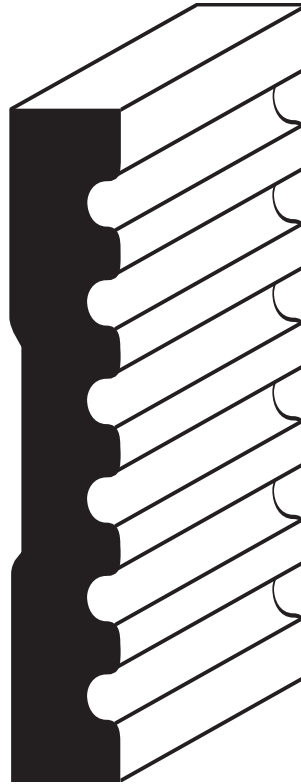

WM1002
Fluted Casing
Finger-Joint
1/2" X 3-5/8"

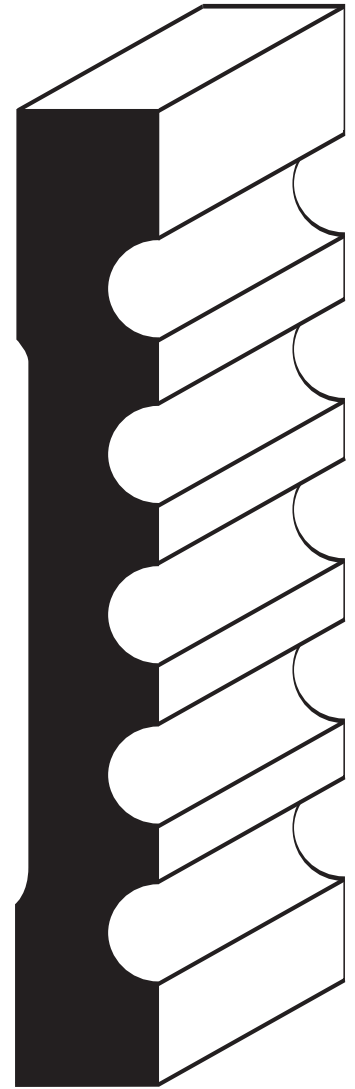

WM1005
Fluted Casing
Poplar 3/4" X 5-1/4"
Finger-Joint, 11/16" X 5-1/4"

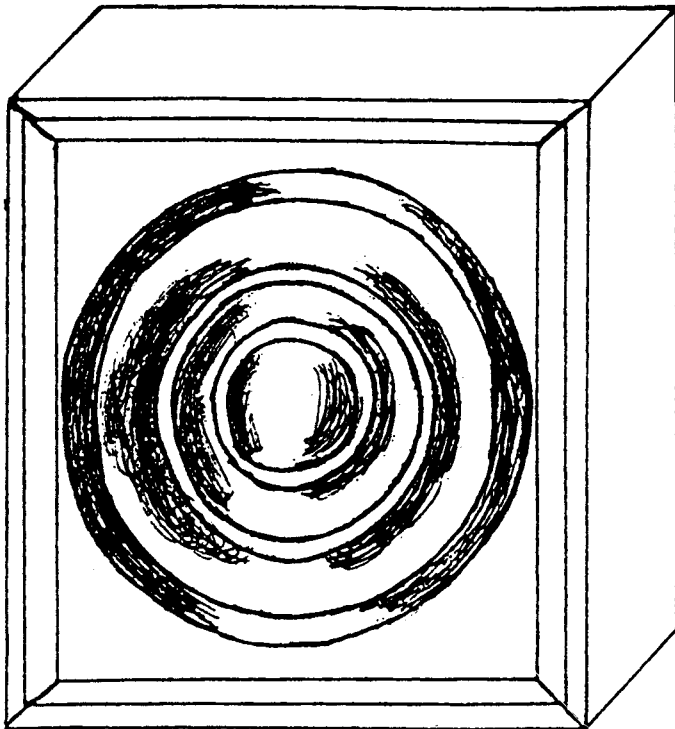

Dished Rosette
Fluted Casing
Clear WM
• 5/4" X 3-1/2"
• 7/8" X 3-3/4"
• 5/4" X 5-1/2"

PLINTHS

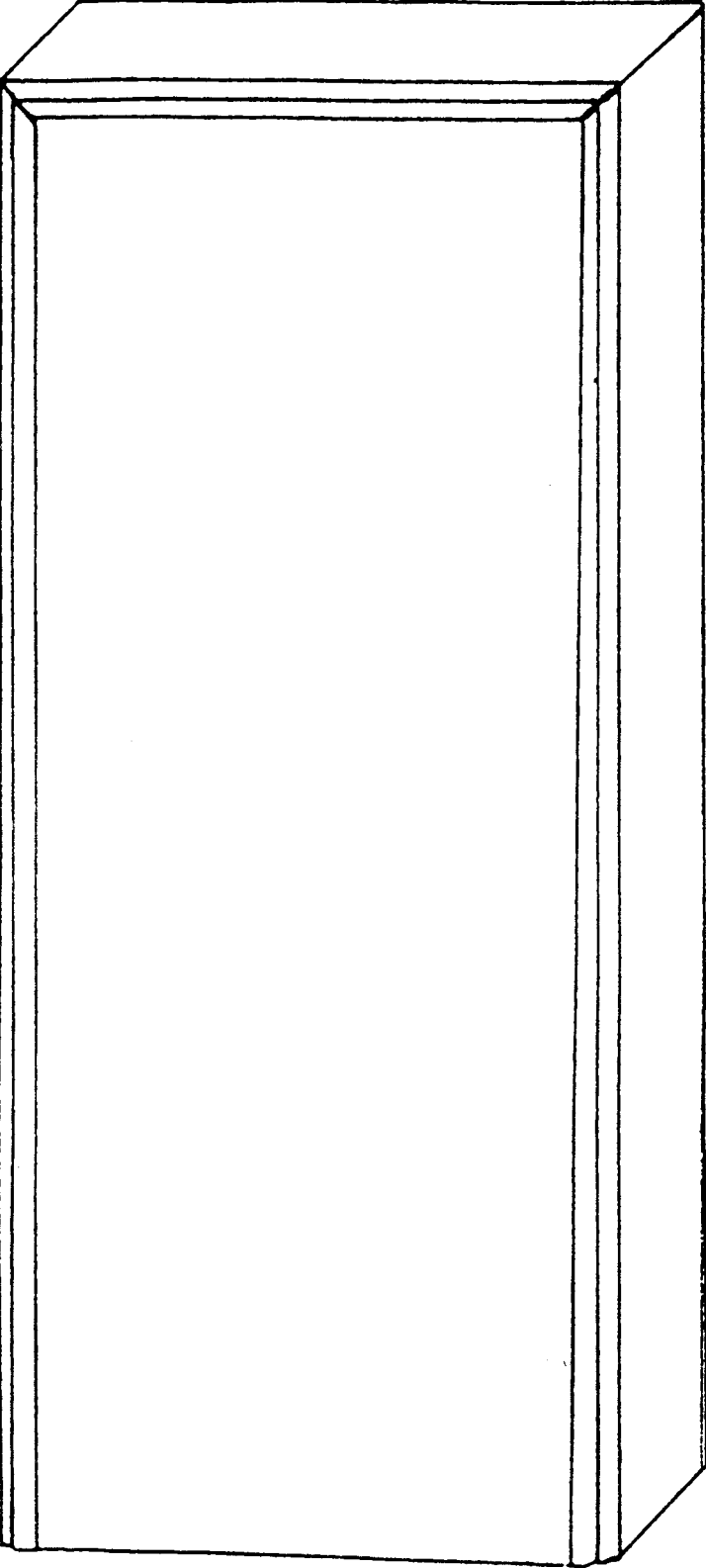
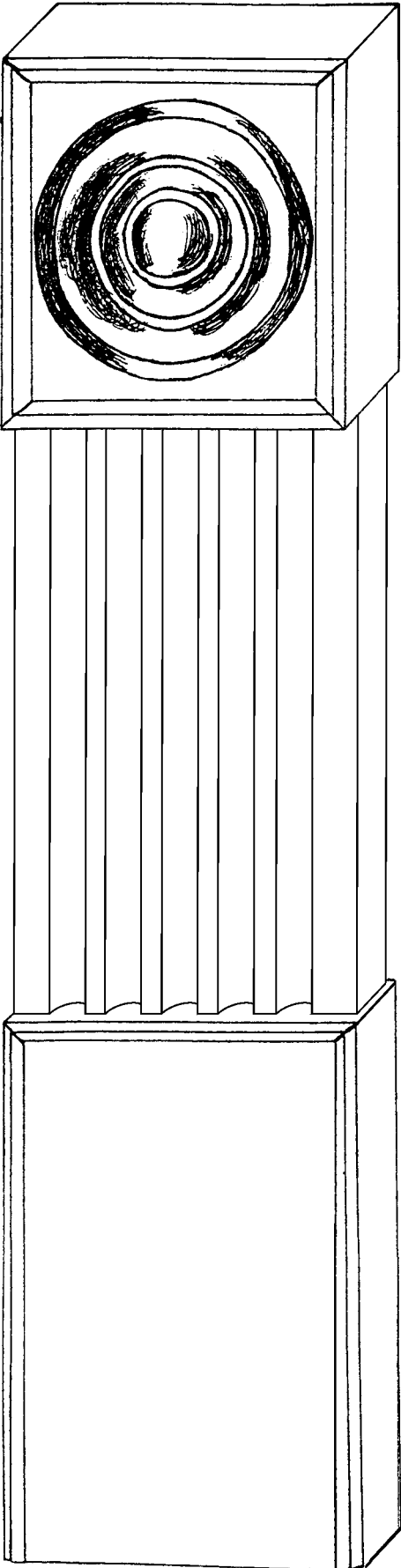

Plinth Block
Clear WM
5/4" X 3-1/2" X 8"
5/4" X 5-1/2" X 8"

Plinth Block
Clear WM
3/4" X 3-3/4" X 6"

CROWN MOULDING

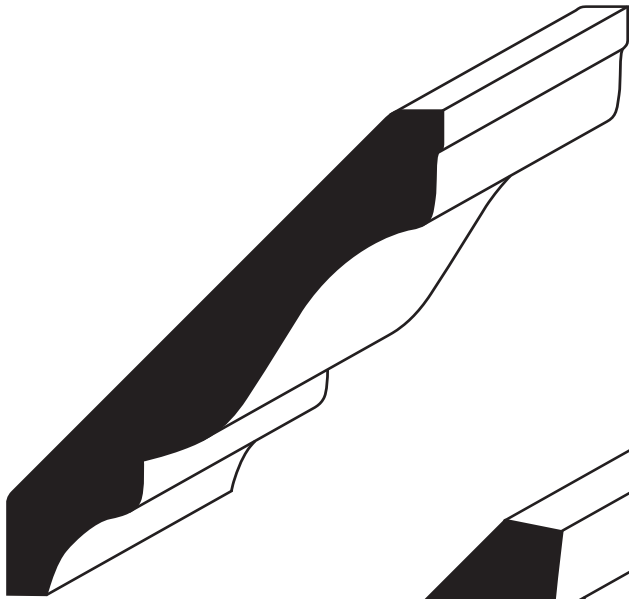

WM-49
Crown
Finger-Joint, Clear
9/16" X 3-5/8"

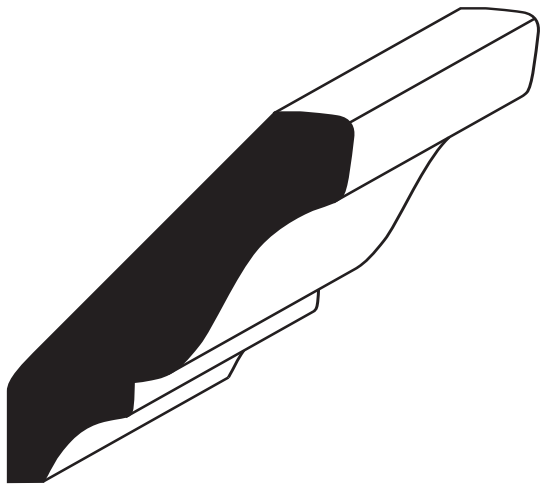

WM-52
Crown
Clear
9/16" X 2-3/4"



WM-47
Crown
Finger-Joint, Clear
Maple & MDF
9/16" X 4-5/8"

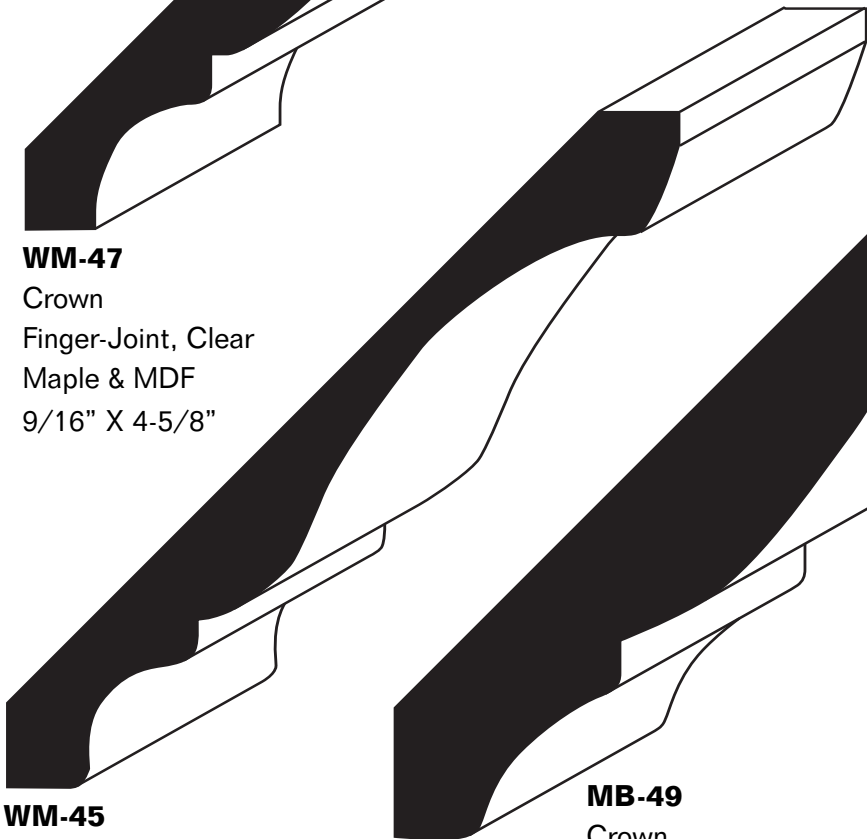

WM-45
Crown
Finger-Joint
9/16" X 5-1/4"

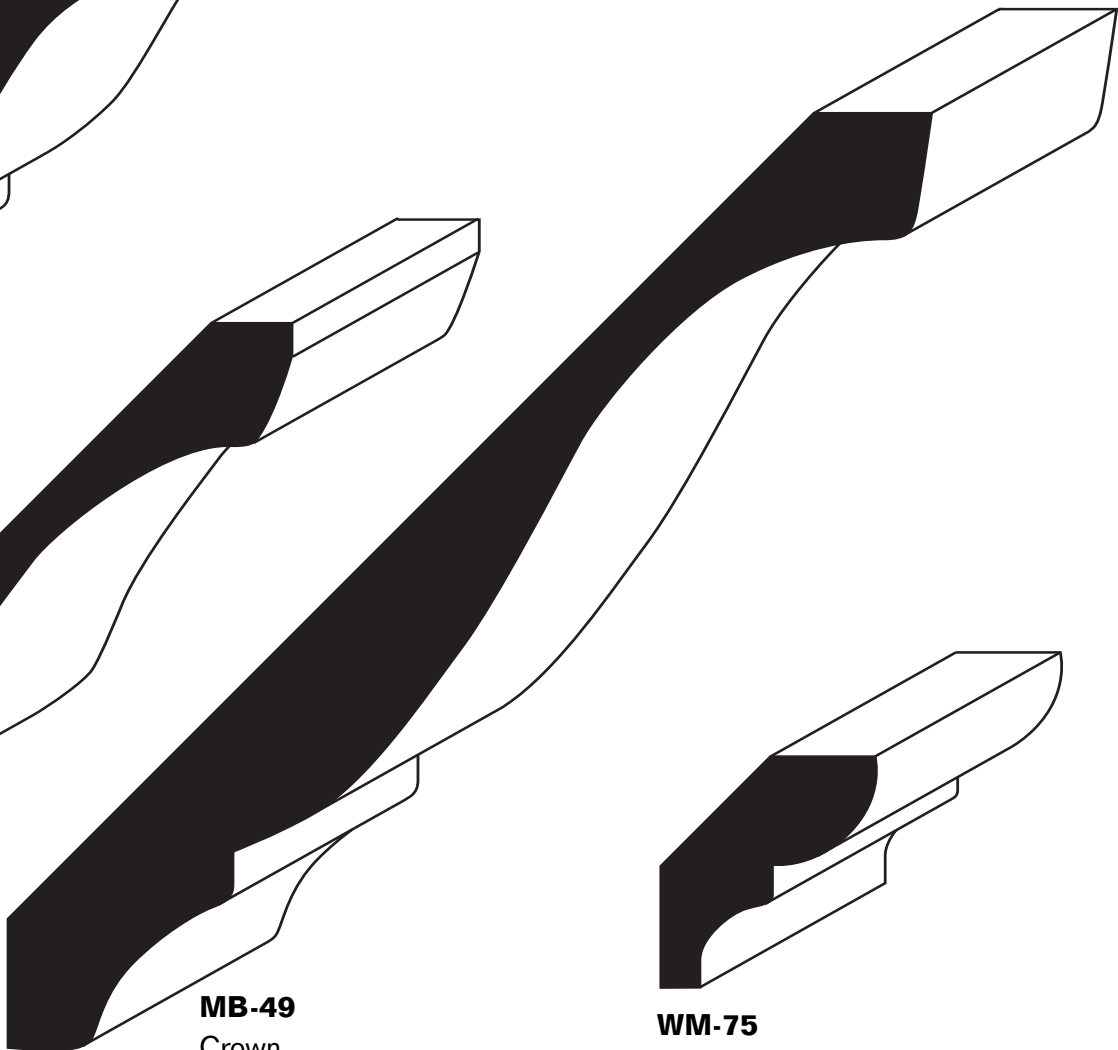

MB-49
Crown
Poplar, 13/16" X 7-1/4"
Finger-Joint, 11/16" X 7-1/4"

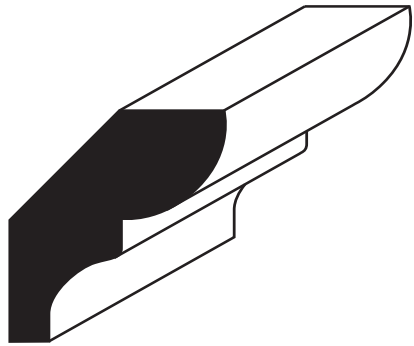

WM-75
Bed Mould
Clear
9/16" X 1-5/8"

CROWN MOULDING

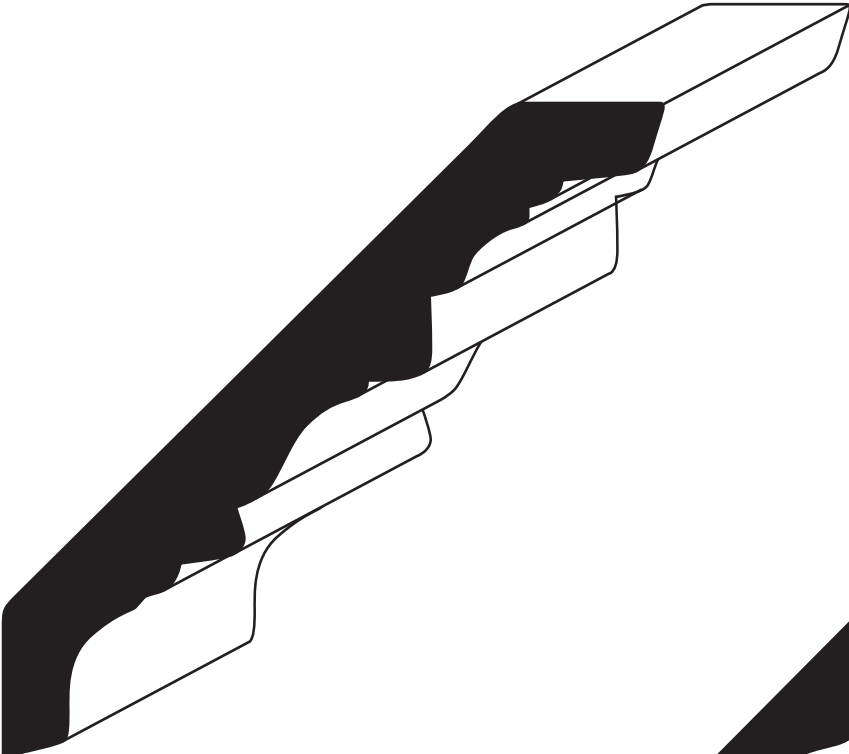

MB-514
Fancy Crown
Poplar
3/4" X 5-1/4"

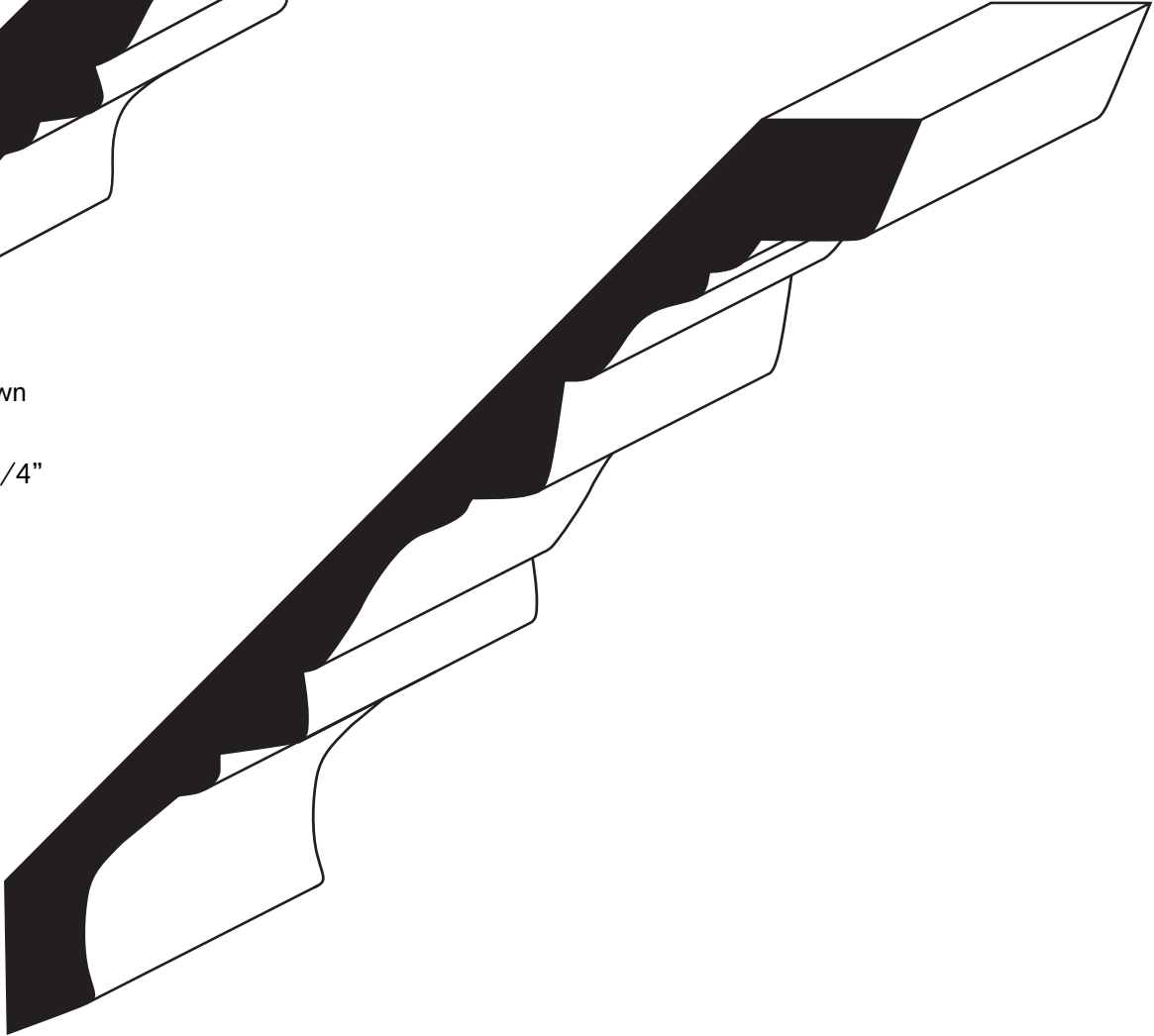

MB-714
Fancy Crown
Poplar
3/4" X 7-1/4"

CROWN MOULDING

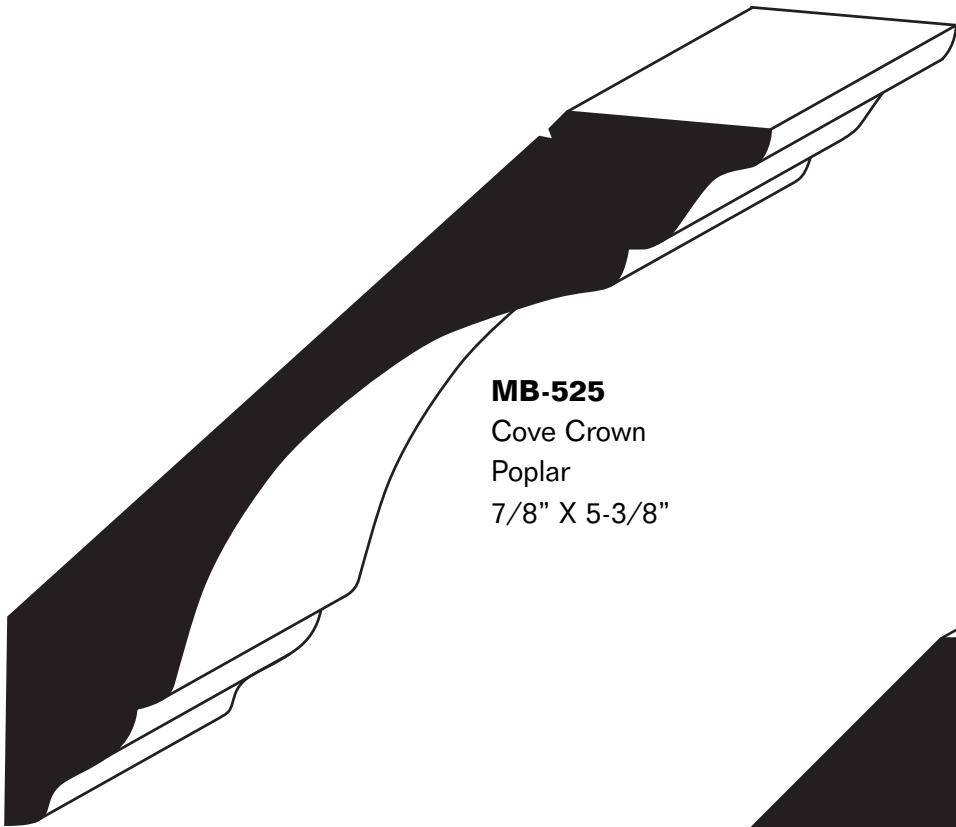

MB-525
Cove Crown
Poplar
7/8" X 5-3/8"



MB-750
Cove Crown
Poplar
1-1/16" X 7-1/2"

CHAIR RAIL

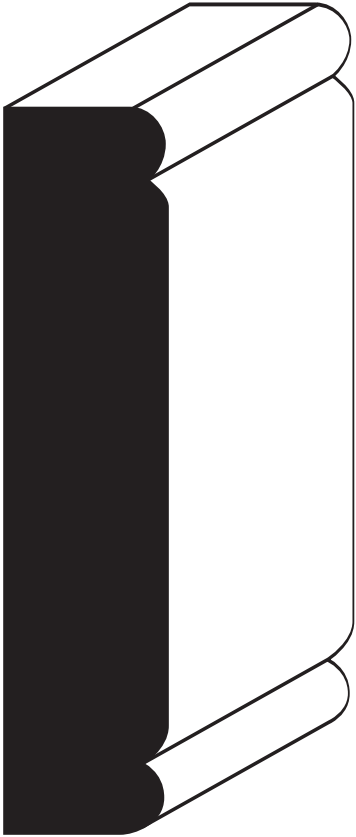

MB-5
Band Backer
Polpar
3/4" X 3-3/4"

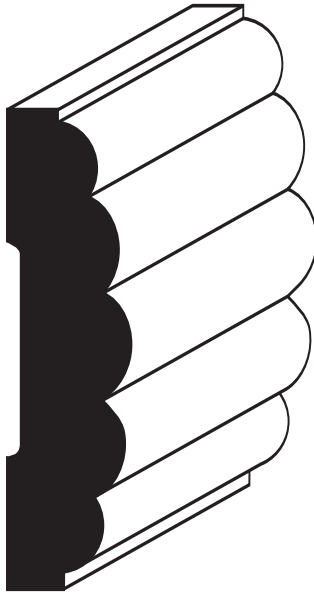

MB-6
Reeded Band
Polpar
5/8" X 2-1/2"



WM-390
Chair Rail
Finger-Joint, Clear & MDF
5/8" X 2-3/8"



WM-302
Chair Rail
Clear
1-1/16" X 2-3/4"

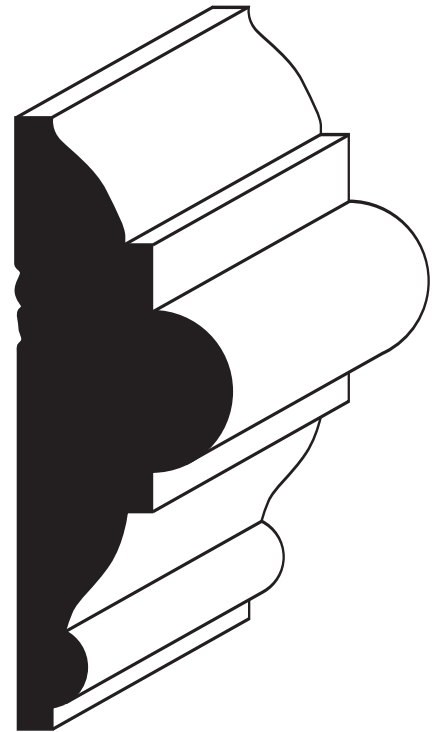

WM-300
Chair Rail
Finger-Joint
1" X 3"

MOULDINGS

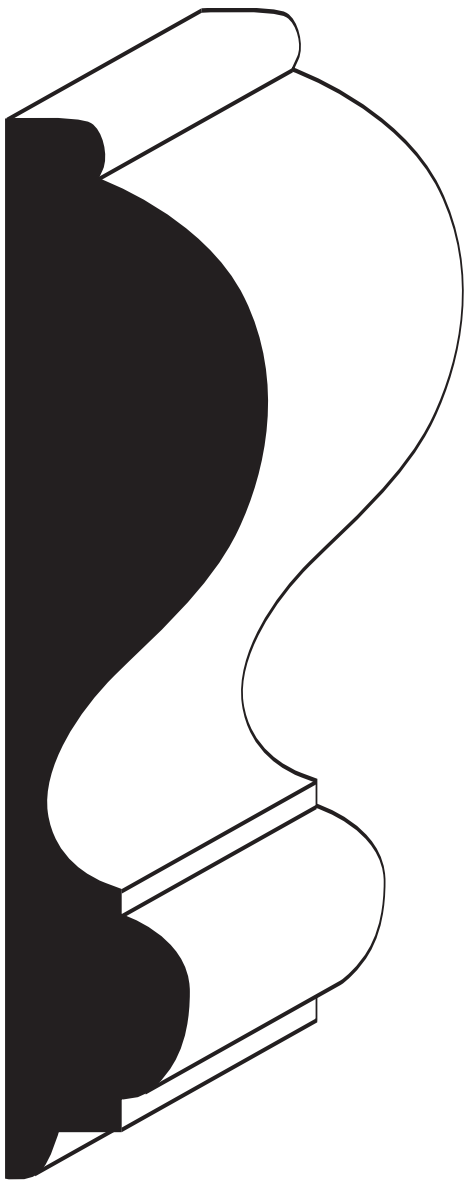

MB-550
Mantle Surround
Poplar
1-1/4" X 5-1/2"



MB-105
Mantle Surround
Poplar
1-3/8" X 3 3/4"

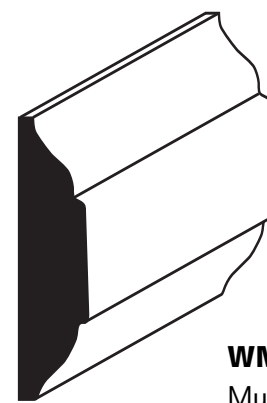

WM-983
Mull Casing
Clear
5/16" X 1-1/8"

WM-988
Mull Casing
Clear
3/8" X 1-3/4"

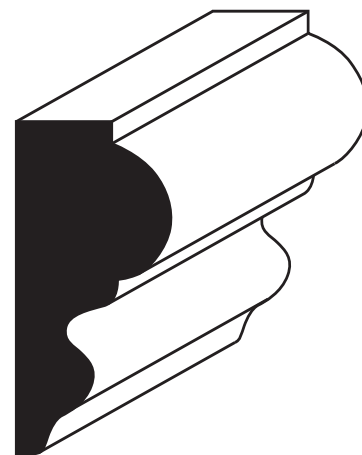

MB-217
Panel Mould
Poplar, Maple
3/4" X 1-5/8"

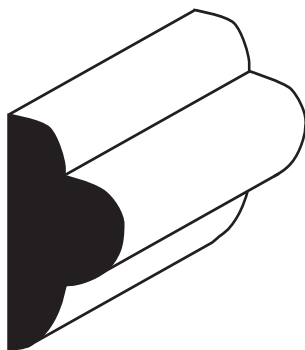

MB-100
Transition Mould
Poplar
5/8" X 1-1/4"

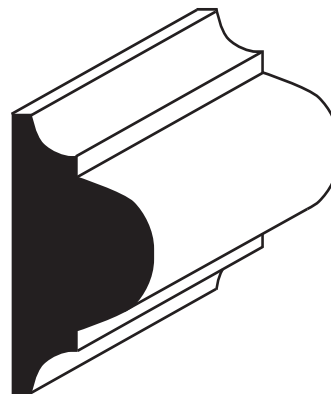

MB-1118
Yeager Mould
Poplar
3/4" X 1-1/2"

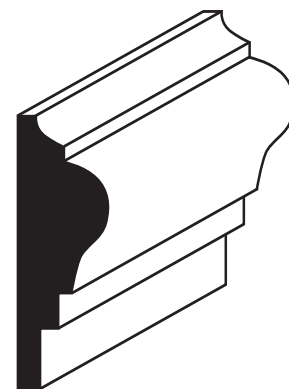

GM-10/1217
Chair Rail
Finger-Joint
1/2" X 1-1/2"

MOULDINGS

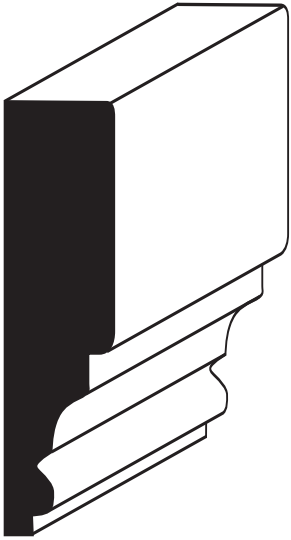

B-2
Apron
Finger-Joint
11/16" X 2-1/2"

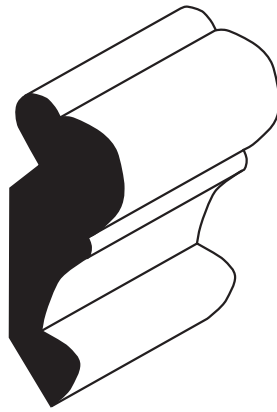

GM-75
Panel Mould
Poplar, 1" X 1-5/8"

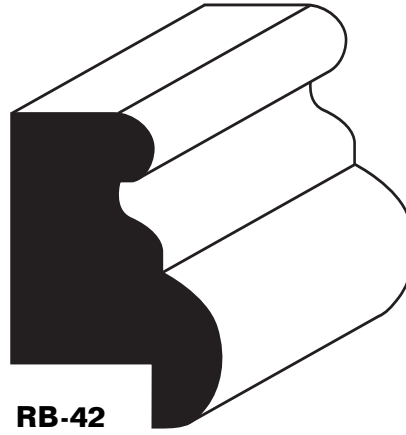

RB-42
Panel Mould
Clear, 1" X 1-5/8"

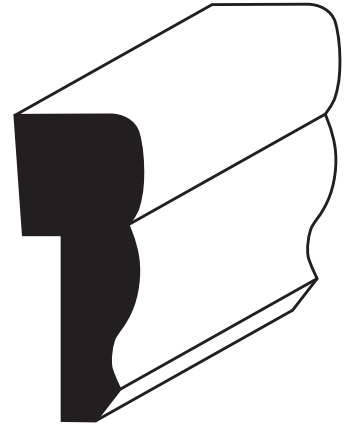

WM-127
Panel Mould
Clear, 11/16" X 1-5/8"

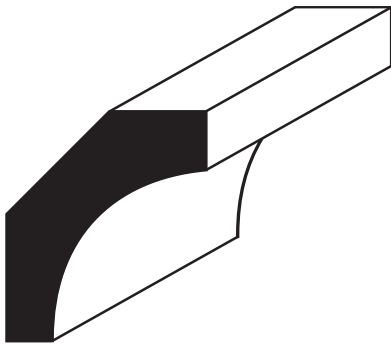

WM-85
Cove
Clear, 1-5/8"

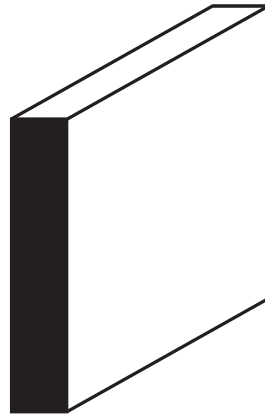

WM-266
Lattice
Clear, 1/4" X 1-1/2"

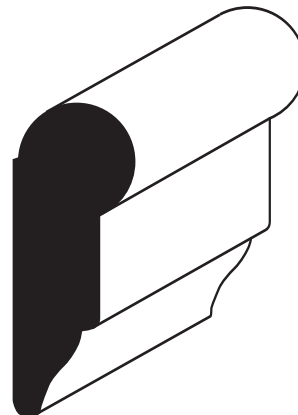

WM-272
Picture Mould
Clear, 11/16" X 1-5/8"

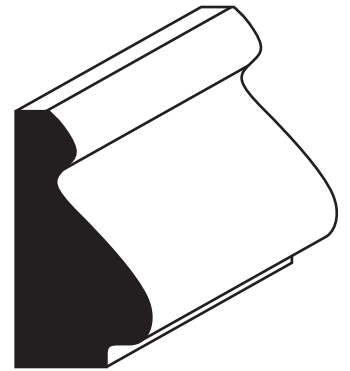

WM-163
Base Cap
Clear, 11/16" X 1-1/4"

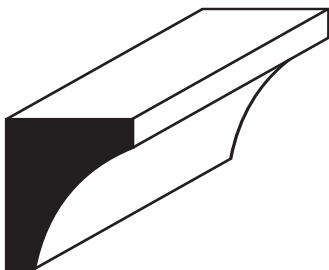

WM-100
Cove
Clear, 11/16"



WM-206
Outside Corner
Clear, 11/16" X 11/16"

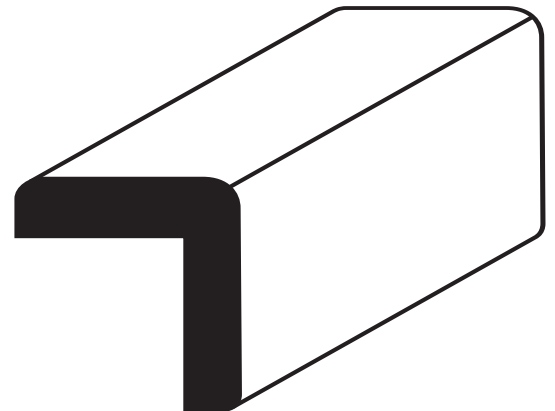

WM-205
Outside Corner
Clear, 1-1/8" X 1-1/8"

MOULDINGS

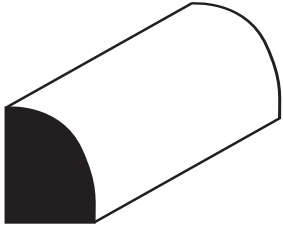

WM-129
Shoe Mould
Clear
1/2" X 5/8"

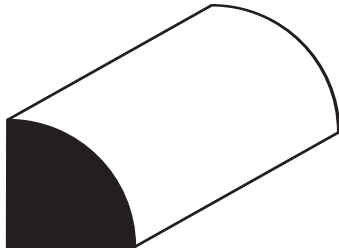

WM-105
Quarter Round
Clear
3/4" X 3/4"

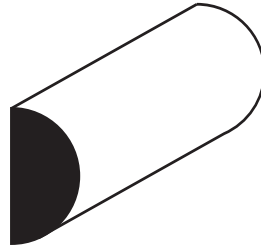

WM-122
Half Round
Clear
11/16" X 5/16"

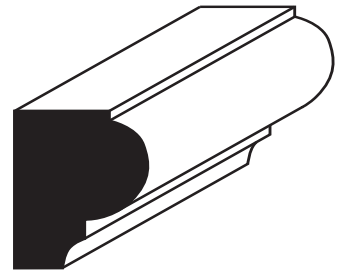

WM-1207
Base Cap
Clear
11/16" X 13/16"

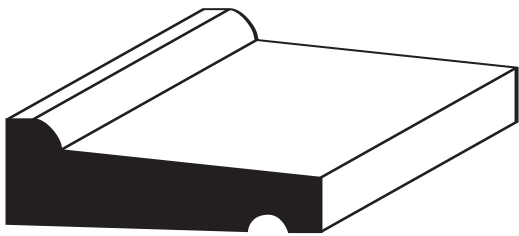

WM-187
Drip Cap
Primed
11/16" X 1-5/8"

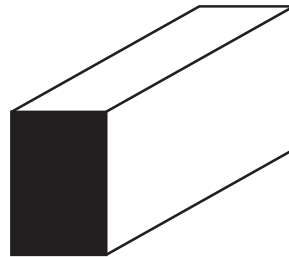

WM-254
Port Bead S-4-S
Clear
1/2" X 3/4"

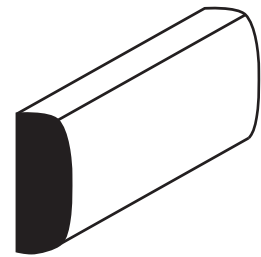

WM-142
Screen Mould
Clear
1/4" X 3/4"



WM-1021
Window Stool
Finger-Joint, 11/16" X 5-1/4"



WM-135
Dentil Mould
Clear, 1/2" X 2"

MOULDINGS

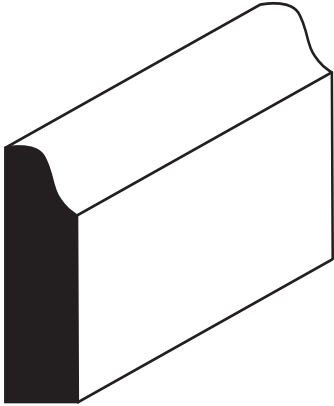

WM-916
OG Stop
Clear, Finger-Joint
3/8" X 1-3/8"

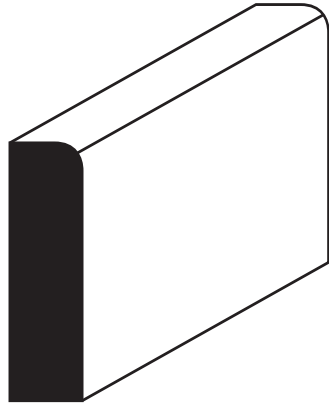

WM-886
Stop
Clear, Finger-Joint
3/8" X 1-3/8"

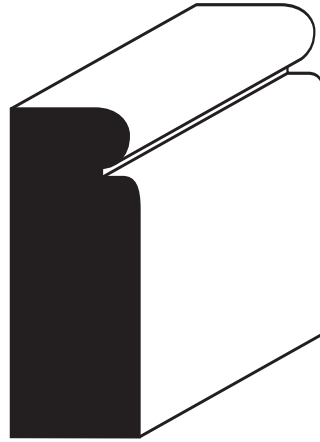

WM-176
Brick Mould
Clear, Finger-Joint
1-5/8" X 5/8"

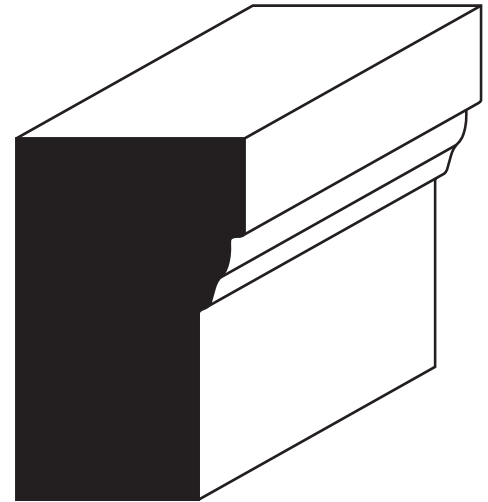

WM-180
Brick Mould
Clear, Finger-Joint
1-7/8" X 1-1/4"

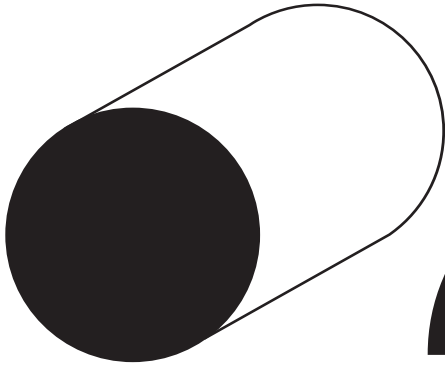

WM-233
Full Round
Clear
1-5/16" X 1-5/16"

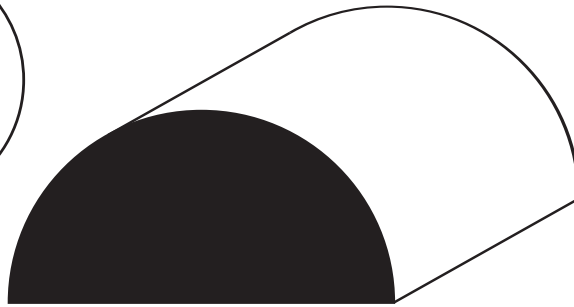

WM-118
Half Round
Poplar
1" X 2"

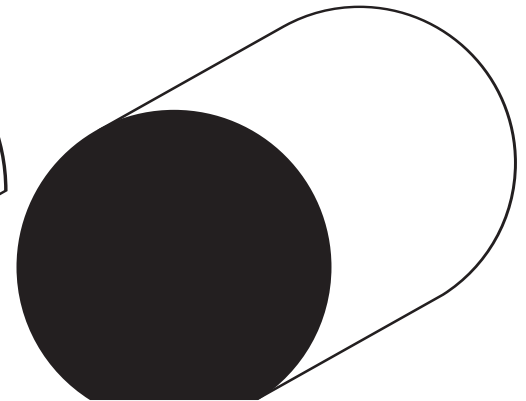

WM-231
Hand Rail
Clear
1-1/2" X 1-11/16"

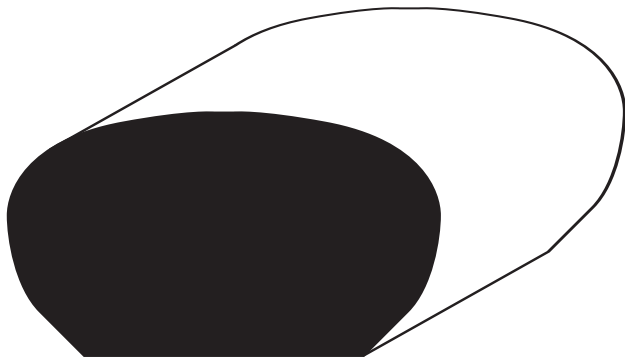

WM-240
Hand Rail
Finger-Joint
2-1/4" X 1-1/4"

STAIR PARTS

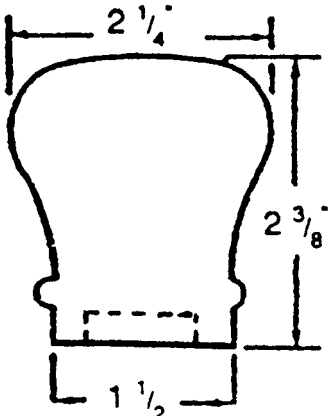

**8070 Mitre Return
Oak Treads**
1-1/16" X 11-1/2"
42", 48", 60"

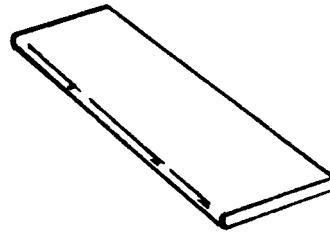
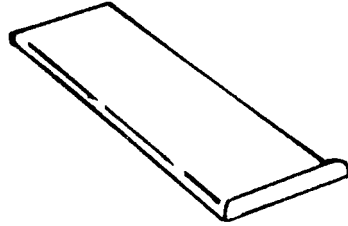

8070 Plain Oak Treads
1-1/16" X 11-1/2"
42", 48", 60"

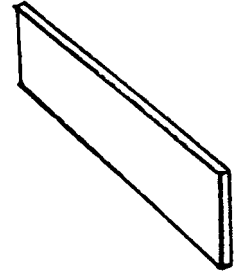

8075 Oak Riser
3/4" X 7-1/2"
42", 48", 60"

6010 Oak Rail

**6010P Plowed Oak
Rail w/fillet**
2-1/4" X 2-3/8"

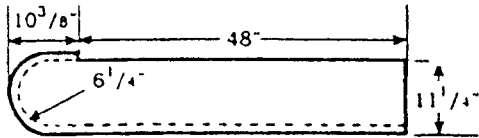

8010 Bull Nose One End
Oak
58-3/8" X 11-1/4" X 6-1/4"

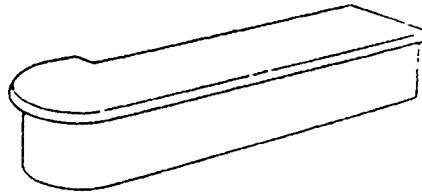

8010-48 Oak Starting Step
8010-60 Oak Starting Step

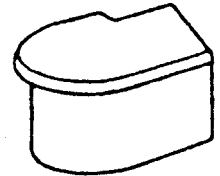

**8010-2 False
End Starting Cap**
Oak

BALUSTERS

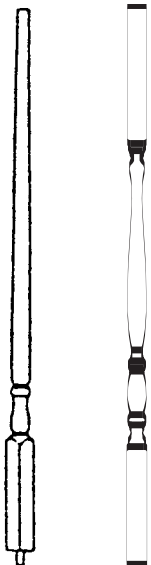

5015 Primed Balusters
31", 34", 36", 39", 41" & 43" Pin Top

5001 Primed Balusters
36", 39" & 41" Square Top Need Pin

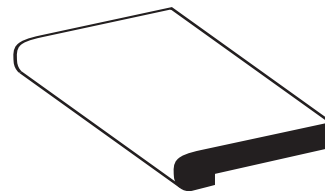

8090-5 Oak Landing Treads
???????????

5015 5001

STAIR PARTS

NEWELS

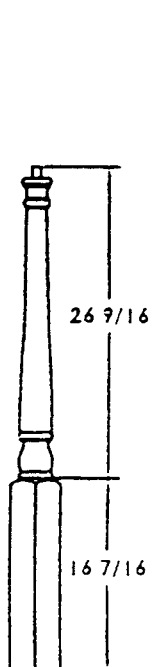

4010-43
Starting Newel
Oak
Pin Top

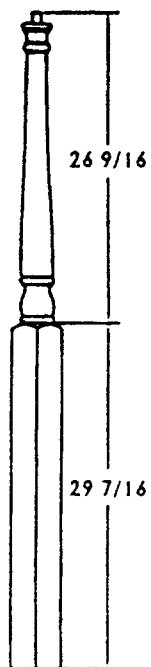

4015-56
Landing Newel
Oak
Pin Top

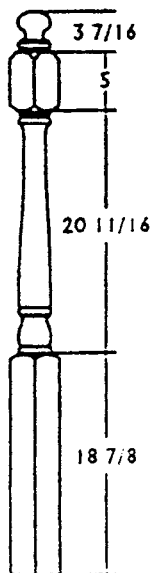

4040-48
Starting Newel
Oak
5" Face
Post to Post

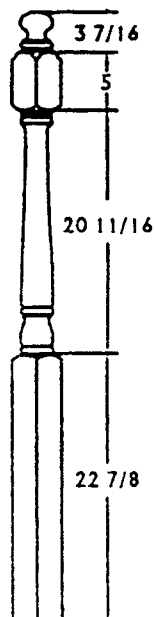

4042-52
Starting Newel
Oak
5" Face
Post to Post

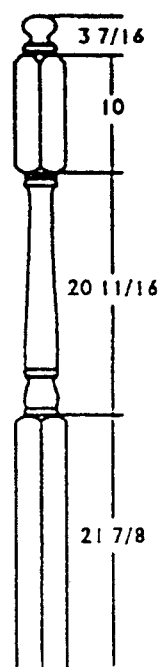

4045-56
Landing Newel
Oak
10" Face
Post to Post

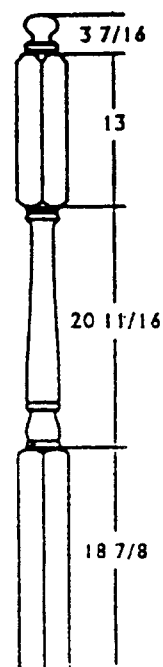

4046-56
Landing Newel
Oak
13" Face
Post to Post

FITTINGS

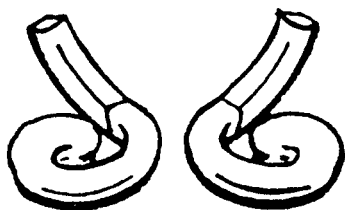

7030 LH & 7035 RH
Volute
Oak

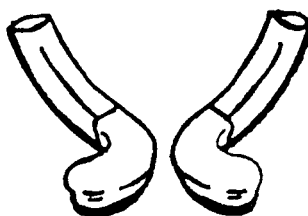

7040 LH & 7045 RH
Turnout
Oak

STAIR PARTS



7008
Coped End
Oak



7009
Returned End
Oak



7010
Starting Easing
with Cap
Oak



7019
Opening Cap
Oak



7012
Up easing 45 Deg.
Oak



7014
Up easing 90 Deg.
Oak



7020
Tandem Cap
Oak



7021
Quarter-turn w/Cap
Oak

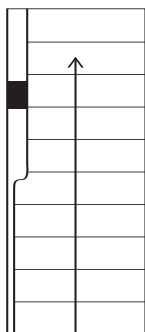

7022-L
Left Hand S-Turn
Oak
5-3/4"



7022-R
Right Hand S-Turn
Oak
5-3/4"

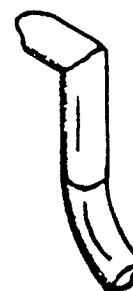
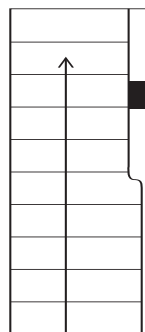

7088-2
Gooseneck 2-Rise
w/Cap
Oak

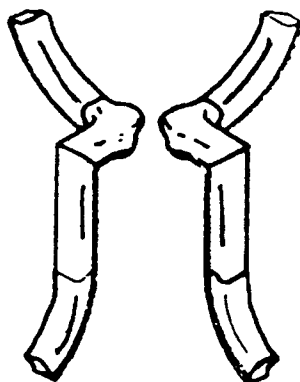

7060 LH & 7065 RH
Gooseneck 2-Rise
w/Cap
Oak

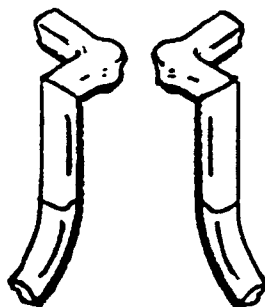

7081 LH & 7086 RH
Gooseneck 2-Rise
Quarter Turn w/Cap
Oak



7099
Gooseneck 2-Rise
Post to Post
Oak

STAIR PARTS – STAIR FASTENERS & TRIM



1000
Fillet

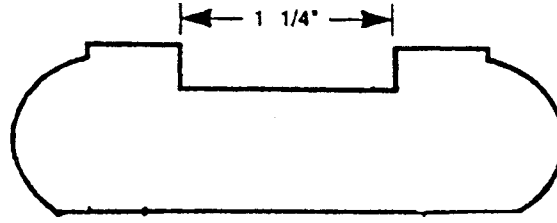

1001
Shoe Rail

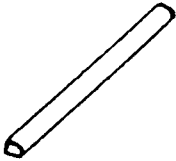

6910
Cove Moulding

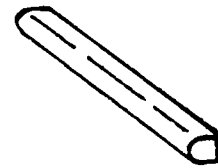

8080
Nosing

ROSETTES

